

---

*: 2008 2 29*

*:*

---

**Yang-Hoon Sonn  
Department of Economics  
University of Incheon**

# AGENDA

---



:



가



가

가	가	
		가
		<
		>
	,	,
	,	,



가

:

가



가

가



가

가

---

1990



	가	



(1999.1)

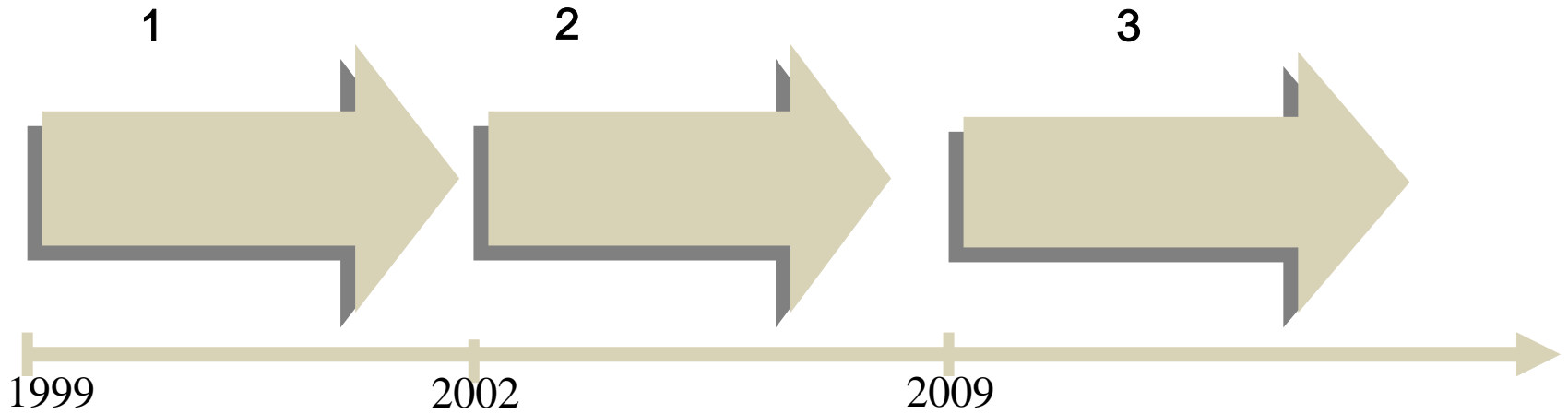



(2004.6)

---



“

”



“

가

”

:



regime)

(old regime)

가

(new



가'



가

,

가

가





가 7

104 (2007 12 )



100%

5  
(97.2%)

			5		
	kWh	1,379	2,258	107	3,744
	%	36.8	60.4	2.8	100.0





가 가



가

가

,

,



가

가

가

,





3



6

,

,



3

2006

2020



2005 12

2006 1



2006

2020

31

가

151

5,546

kW

,



56%



가



가

가



가

가



가



가







# Energy Security

---



가 가

, EU, ,

가



Energy Security

가 가





가

,

가

가

,



가

9



2013



가



가

.



option



:



• Debt Financing -> Equity Financing



option

가



가

가



---

2008

가



, 가



.  
, , , ,



가

---

가

가

,

.

가

.

.



,

,

,

,

,



가

가

가



가

가



가





가

가



,

,



100%

5





(Efficiency)



(Adequacy)



(Reliability)



가



:

,

:

,

,

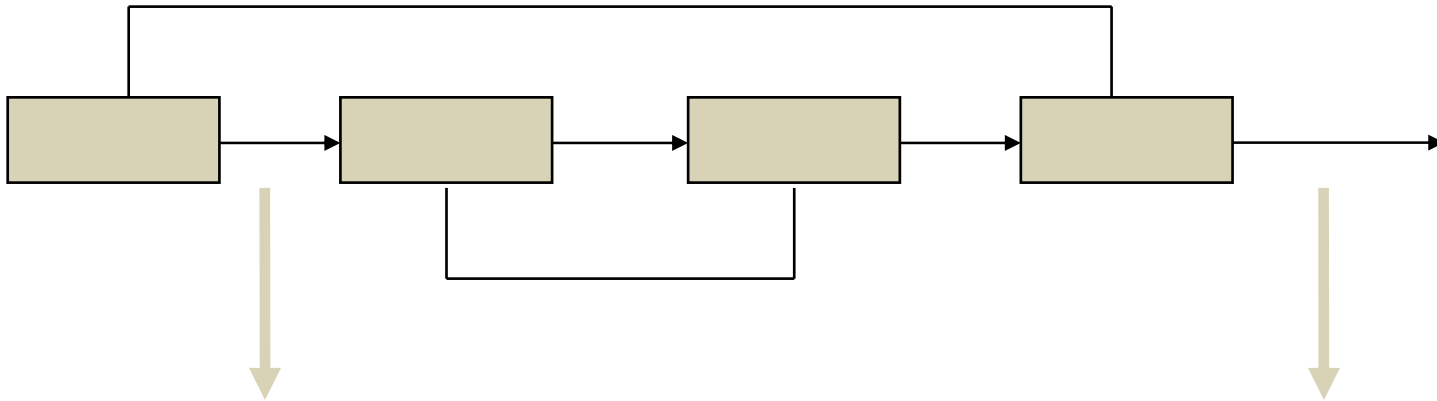

# OECD 가

	1990	2003
	, , , , , , , , , , , , , , ,	, ,
		,
	,	, , , , , , , , , , , ,

# OECD 가

	1990	2003
	, , , , , , , , , , , , , , ,	, , , , (2001), , (2001)
		, , , , , , , ,

# 가

---

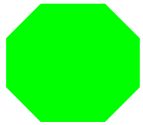

2001

6

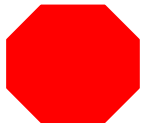



---

가

가

:



가 가





(eligible customers)



가



.



,

가

.



가

/

.



가

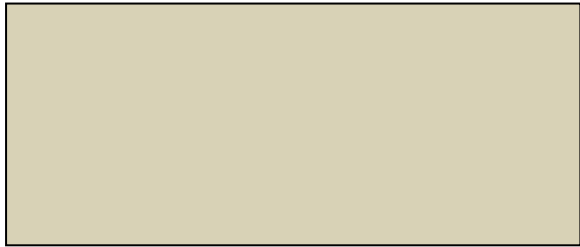

,

.



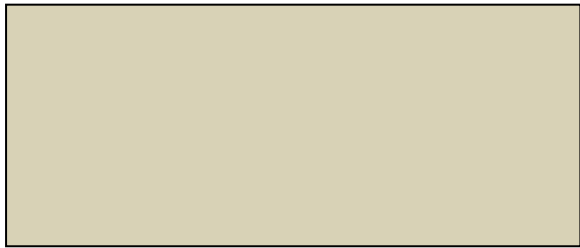





 -  

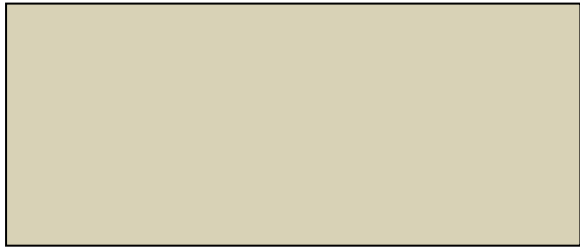

 ( ) ( )  
 가  

 가 ,  
  
 가 -

( 3 )

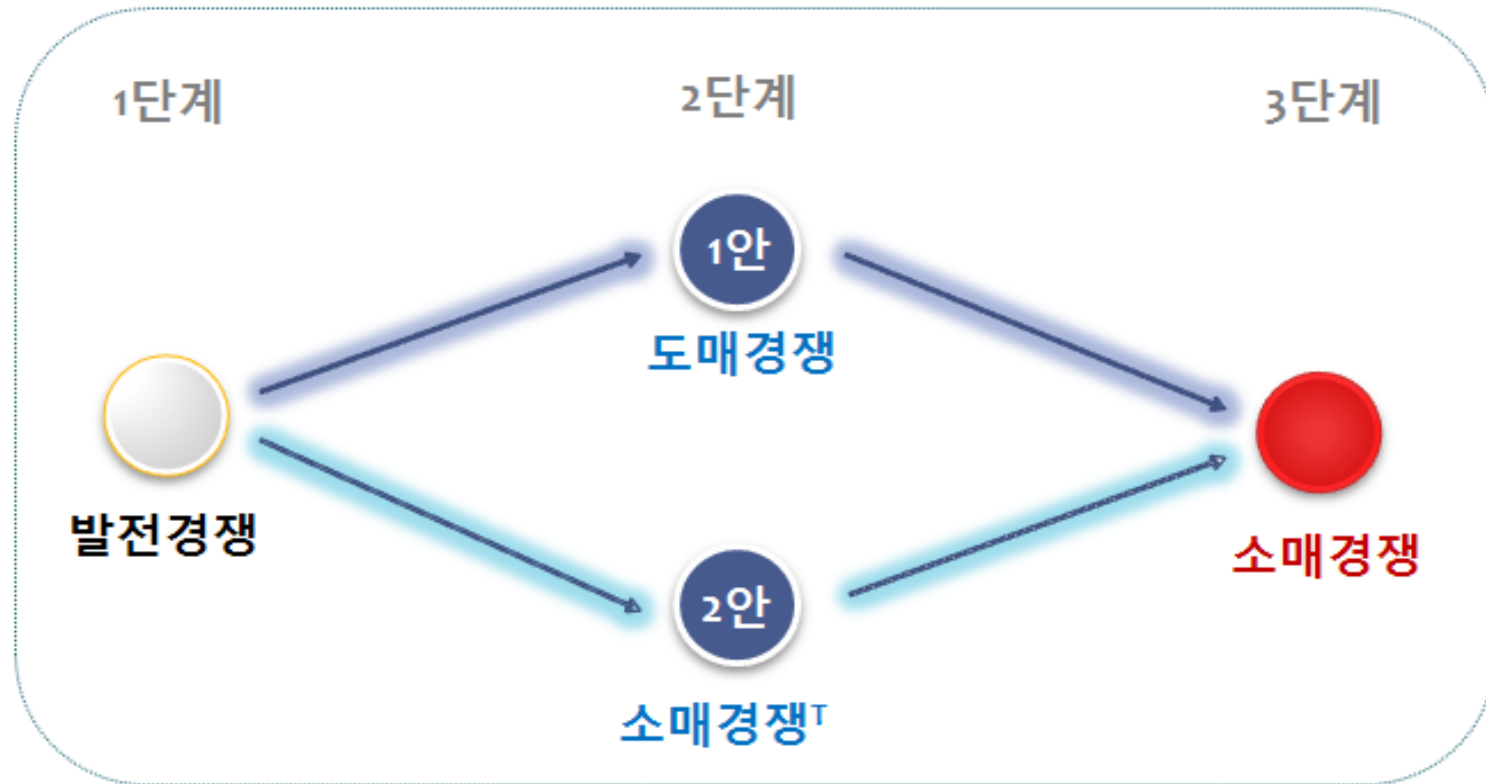

# 가

1 : :  
-

- ,
- 
- ,
- 1999

2 : :

- 가
- - 가
- -
- 

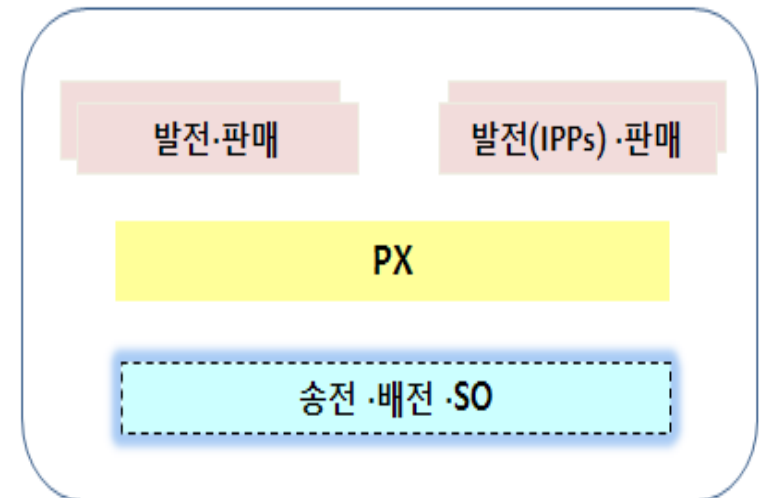
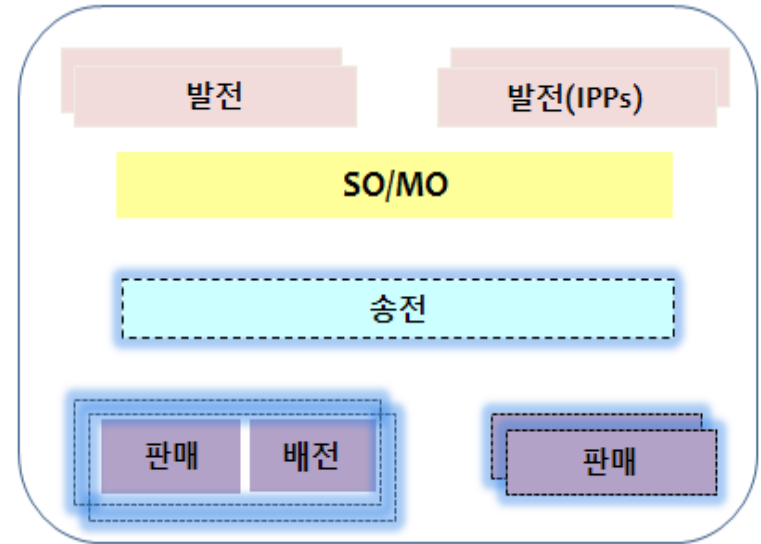

1

:



1999

.



,

, 2015



( )

,

( )

,

가



/

가

.

(two-

way bidding pool)



가

,

(SO/MO)

2

:



+

1999



1

가

,

,

,

, 2015



( IPPs)  
PX (Power eXchange),  
가

가

,

,

가

가



가

가



,



,

,



&

---



,

,



,

가



---

 Last Resort



가?



가?



가

( )



# 1 (CBP)

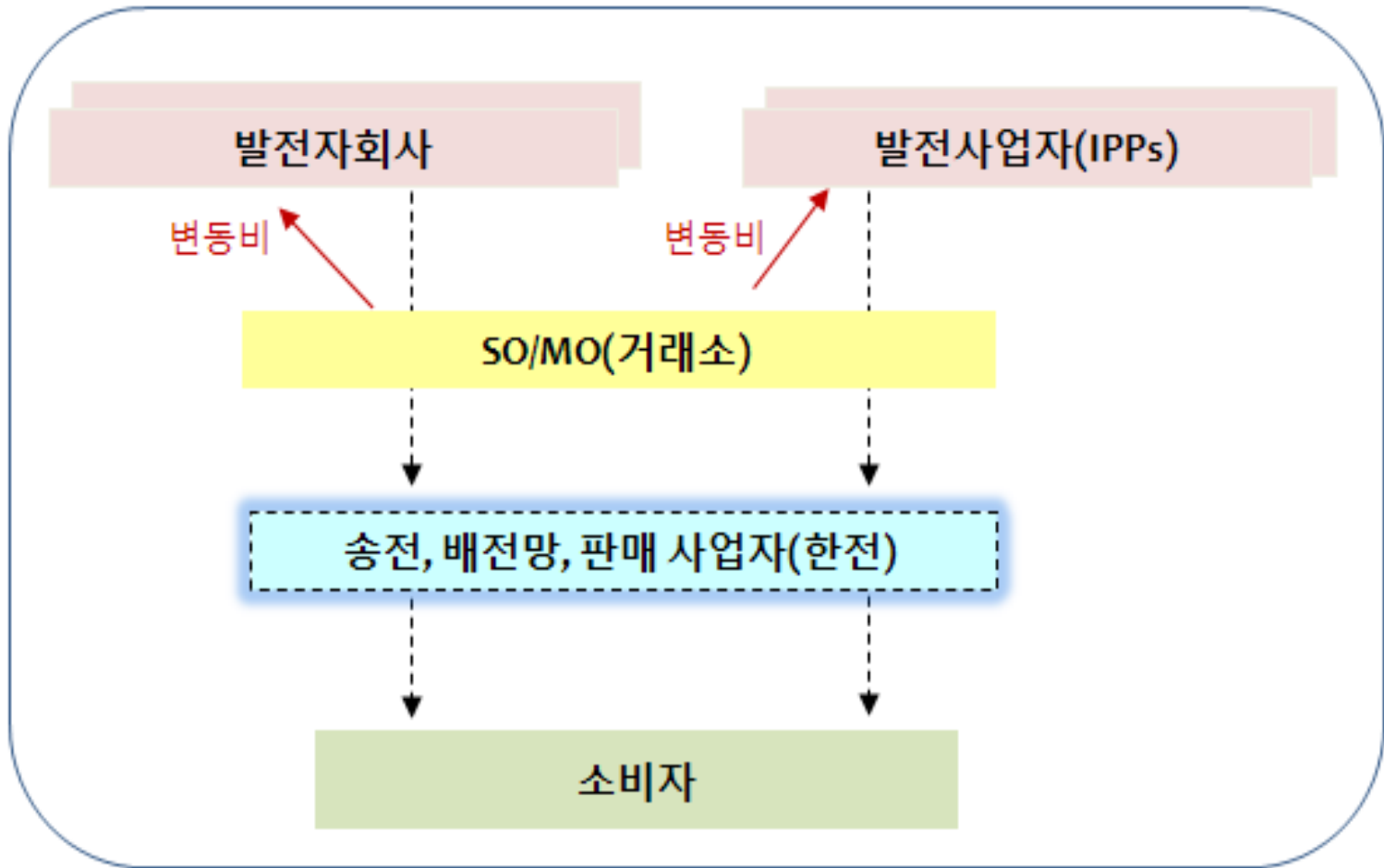

( )



2 ( + )

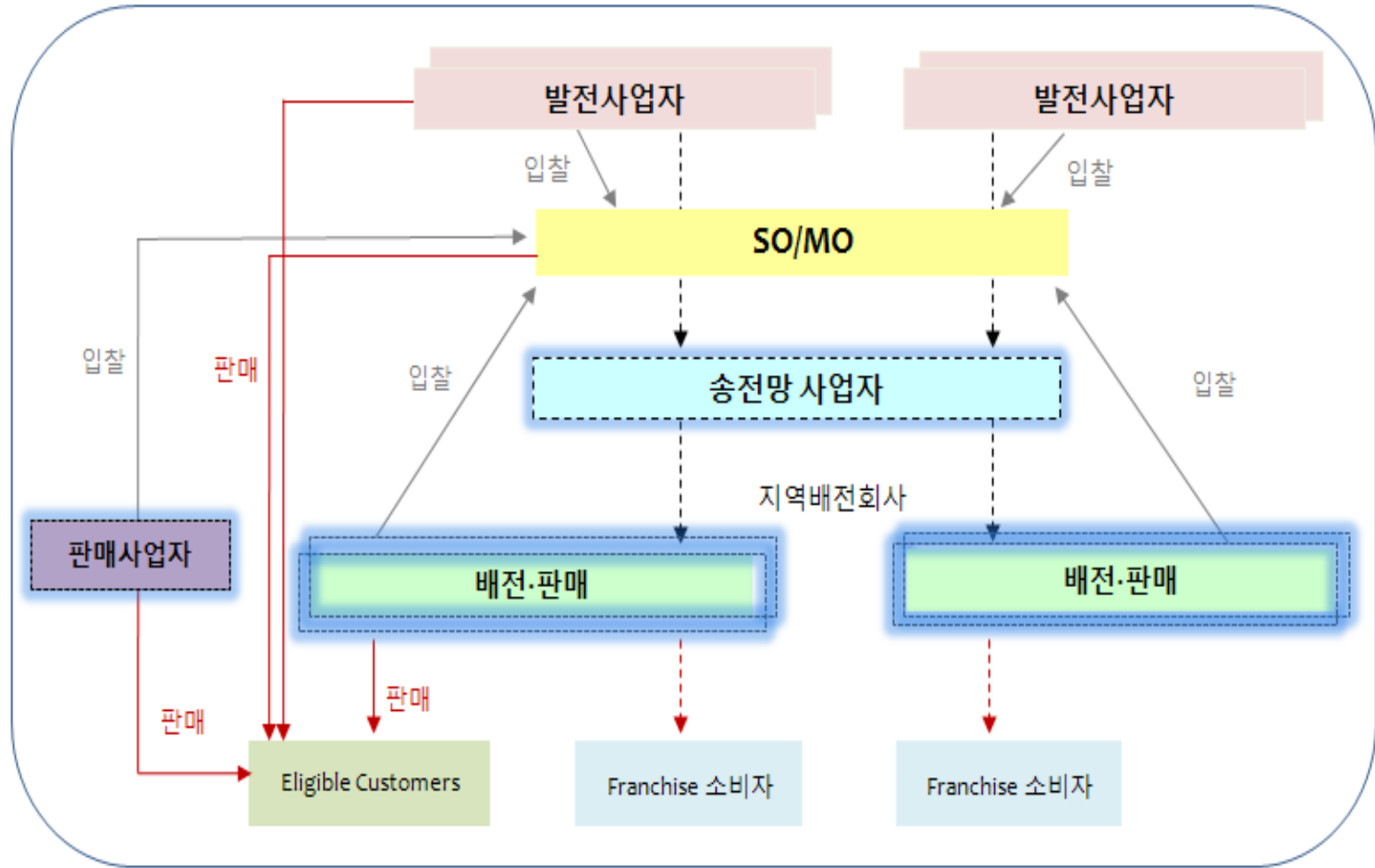

( )



2 ( + )

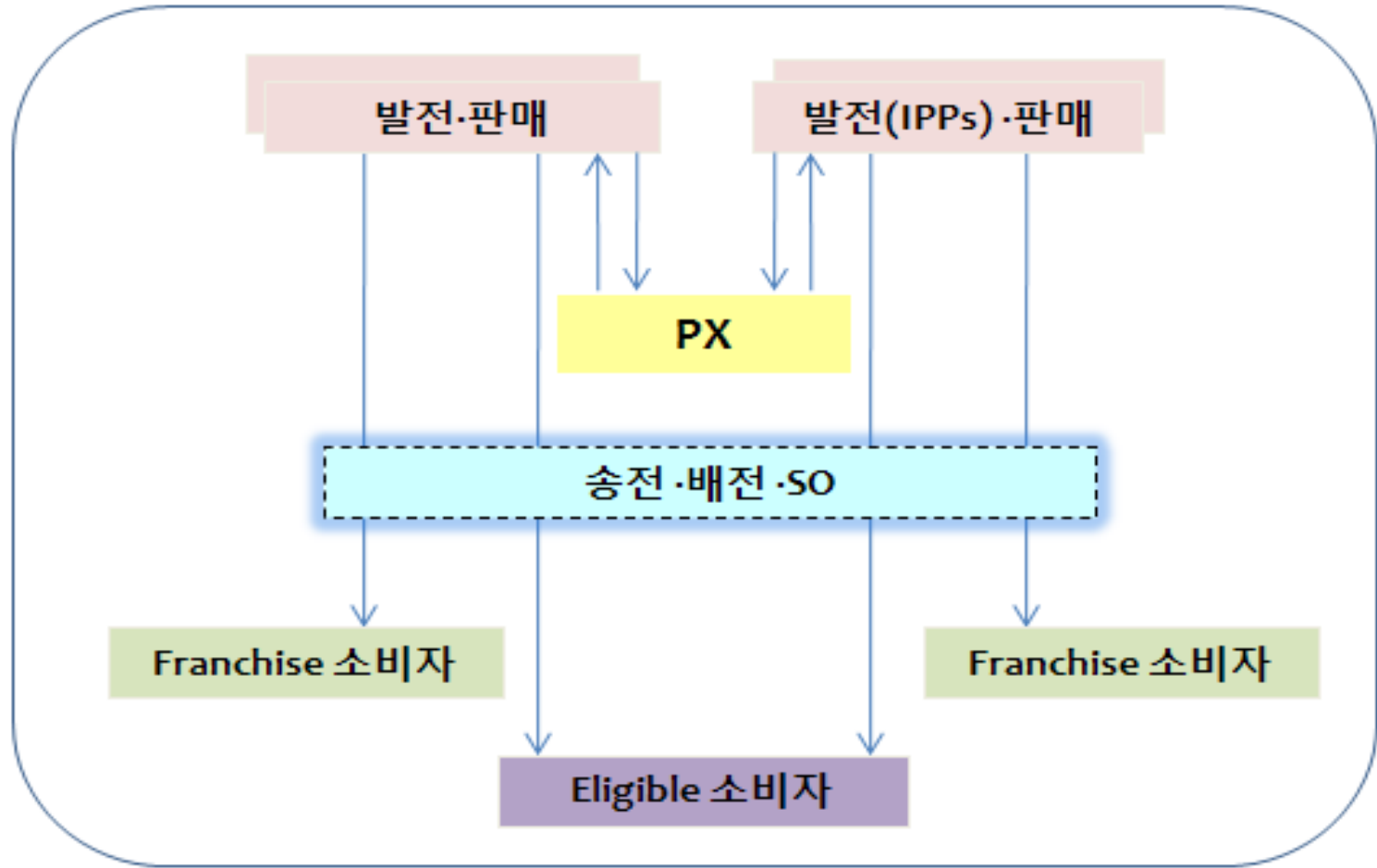

( )



3 ( )

